



CLASS-RITE®

Wall / Ceiling Projection Screen

SPECIFICATION DATA

DA-LITE SCREEN COMPANY, INC.
 3100 North Detroit Street
 Post Office Box 137
 Warsaw, Indiana 46581-0137
 Phone: 219/267-8101
 800-622-3737
 Fax: 219/267-7804
 http:// www.da-lite.com
 e-mail: info@da-lite.com

SUGGESTED SPECIFICATIONS: _____ projection screens, _____ (H) x _____ (W), wall or ceiling mounting type. To have an octagon steel case with flat back design with baked enamel finish and fitted with heavy duty plastic end caps with nylon bearing surface to support roller. End caps to have brackets for wall mounting by means of slotted screw holes and ceiling mounting by means of powder coated D rings. To have matte white surface on flame retardant and mildew resistant fabric. Top of fabric shall be mounted into a metal strip in a metal Camlok roller system without tape, glue, staples or cords so that fabric may be easily replaced, yet cannot be pulled accidentally from roller. Bottom of fabric shall be mounted into a metal strip in a tubular steel slat finished in baked enamel. Ends of slat shall be protected by plastic outer caps. Plated steel slat pull shall be attached to slat with screws.

DIMENSIONS

Sizes		A - Overall Length of Case		B - Distance Between Hanger Eyes		Approx. Ship. Wt.	
H x W	Cm	In.	Cm	In.	Cm	Lbs.	Kg
50" x 50"	127 x 127	53 ³ / ₈ "	136	52 ⁵ / ₈ "	134	10	4.54
60" x 60"	152 x 152	63 ³ / ₈ "	161	62 ⁵ / ₈ "	159	13	5.90
70" x 70"	178 x 178	73 ³ / ₈ "	186	72 ⁵ / ₈ "	189	15	6.80

Specifications subject to change without notice.

PLEASE MARK APPROPRIATE SELECTIONS:

Optional Accessories:

- No. 6 Wall Bracket – extends 6" (15 Cm).
- No. 11 Wall Bracket – extends 10" (25 Cm) or 14" (36 Cm).
- No. 23 Adjustable Wall Bracket – extends 18¹/₄" (46 Cm), 20" (51 Cm) or 24" (61 Cm).
- T-Bar Scissors Clip – for dropped ceilings.
- Tilt Lock – keystone eliminator.
- Pull Rod.

OPTIONAL ACCESSORIES

EXTENSION WALL BRACKETS

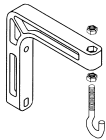

No. 6 WALL BRACKET

Screen can be extended 6" (15 Cm) from wall.

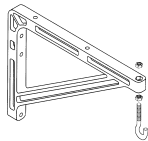

No. 11 WALL BRACKET

Screen can be extended 10" (25 Cm) or 14" (36 Cm) from wall by changing position of bracket.

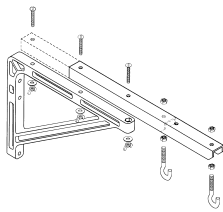

No. 23 WALL ADJUSTABLE BRACKET

Screen can be extended 18¹/₄" (46 Cm), 20" (51 Cm) or 24" (61 Cm) from wall by wing nut and bolt adjustment.

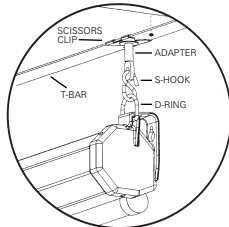

T-BAR SCISSORS CLIP for dropped ceiling. 50 lb. (22.68 Kg) capacity.

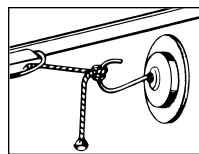

TILT LOCK for Keystone elimination. Used with extension brackets or T-Bar Scissor Clips.

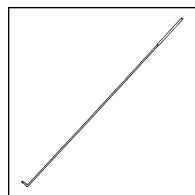

PULL ROD
 Plated steel rod with black plastic handle grip allows easy access to screen when mounted out of reach. Also can be used as a pointer.

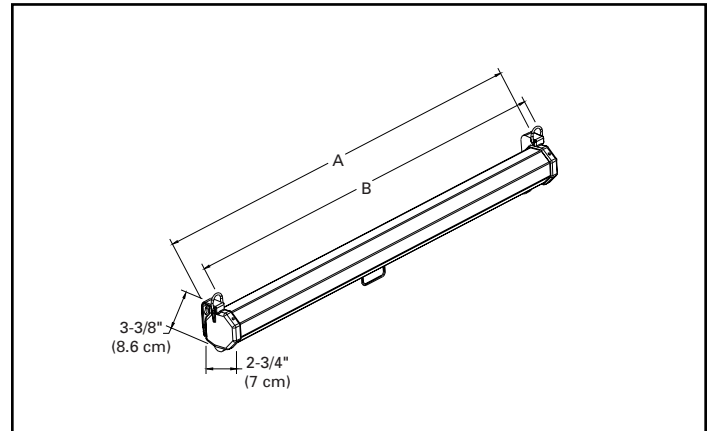

Project: _____

Architect: _____

Phone: _____

Contractor: _____

Phone: _____

Supervisor: _____

Phone: _____

Date: _____

Revised: _____